



# LuxStudio

## Y-Not Table



## Y-Not Table Round Range

3-Leg, 720mm H



900mm Ø

---

4-Leg, 720mm H



1000mm Ø



1200mm Ø

---

5-Leg, 720mm H



1200mm Ø

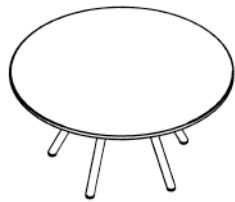

1500mm Ø

---

6-Leg, 720mm H



1500mm Ø

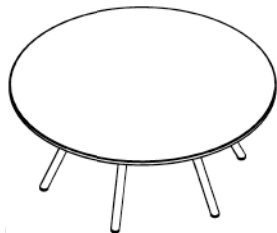

1800mm Ø

---

## Y-Not Table Square Range

4-Leg, 720mm H



900mm x 900mm



1000mm x 1000mm

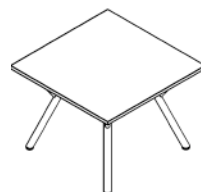

1200mm x 1200mm

## Y-Not Table Lotus Range

3-Leg, 720mm H



900mm Ø



1000mm Ø



1200mm Ø

---

## Y-Not Table Rectangle Range

4-Leg, 900mm W, 720mm H



1200mm x 900mm



1500mm x 900mm

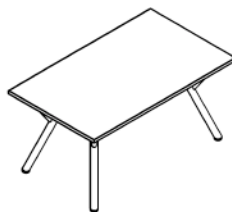

1800mm x 900mm

---

6-Leg, 900mm W, 720mm H

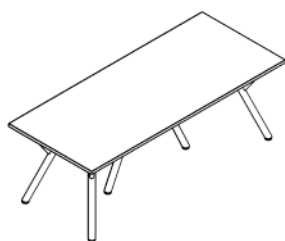

2100mm x 900mm

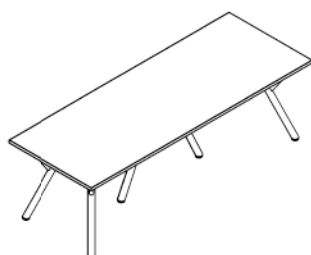

2400mm x 900mm

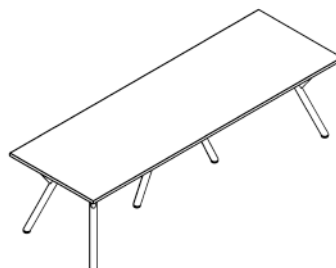

2700mm x 900mm

---

4-Leg, 1000mm W, 720mm H



1200mm x 1000mm

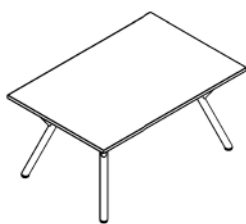

1500mm x 1000mm

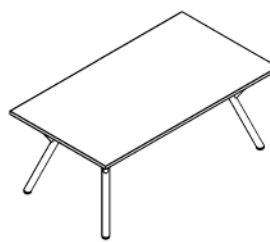

1800mm x 1000mm

---

6-Leg, 1000mm W, 720mm H

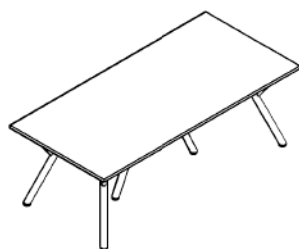

2100mm x 1000mm

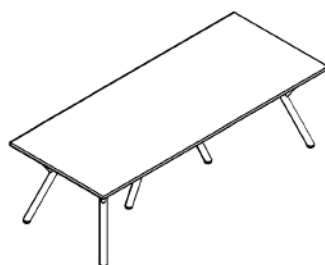

2400mm x 1000mm

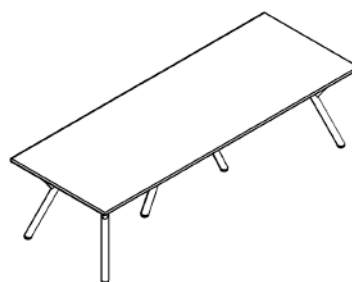

2700mm x 1000mm

## Y-Not Table Rectangle Range

4-Leg, 1200mm W, 720mm H

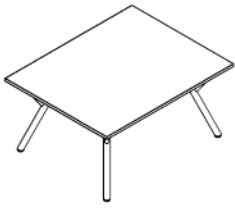

1500mm x 1200mm

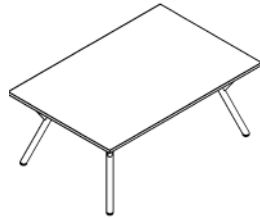

1800mm x 1200mm

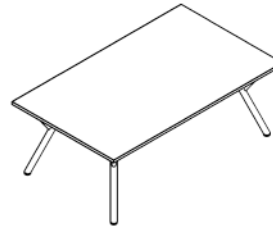

2000mm x 1200mm

---

6-Leg, 1200mm W, 720mm H

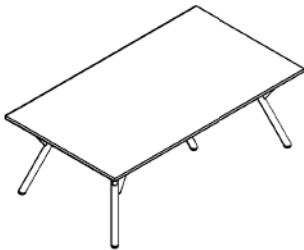

2100mm x 1200mm

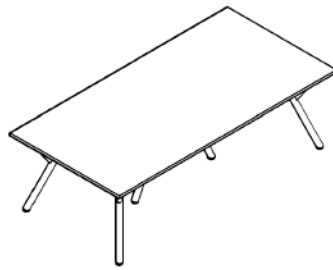

2400mm x 1200mm

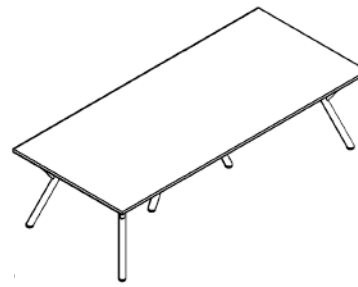

2700mm x 1200mm

---

6-Leg, 2-Piece Top, 1200mm W, 720mm H

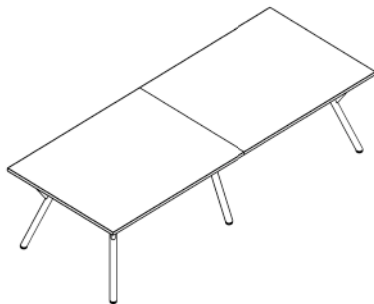

3000mm x 1200mm

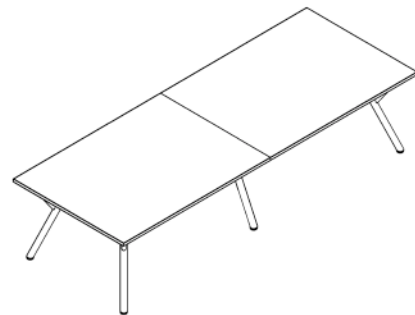

3200mm x 1200mm

---

8-Leg, 2-Piece Top, 1200mm W, 720mm H

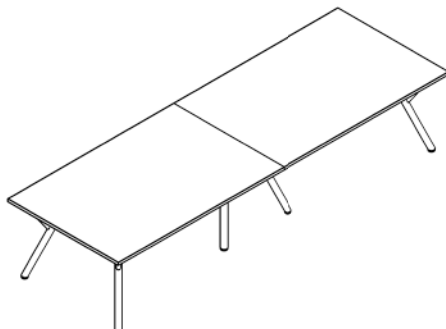

3600mm x 1200mm

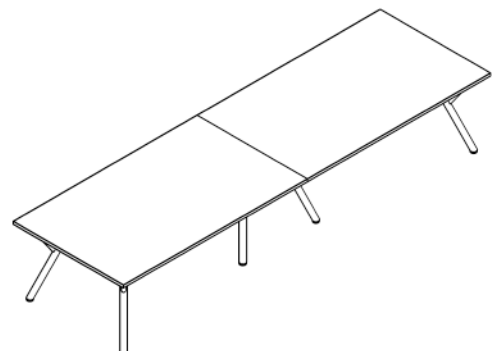

4000mm x 1200mm



## Y-Not Table

The Y-Not range, designed by Lux Studio, is an elegant angled timber-legged table.

Y-Not can be utilised to produce a number of different table options ie. meeting, cafe and general use.

The Y-Not table range's legs can be stained to suit different colour requirements.

This product is Australian made, and in an environmentally sustainable factory; it is also GECA certified.

Material	Tasmanian Oak
	Metal
Lead time	4-6 weeks
Warranty	5 years
Certified	ISO 14001
	GECA

